

## TUNG-SOL

## BEAM PENTODE

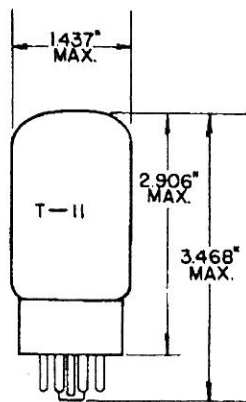

GLASS BULB  
SHORT INTERMEDIATE SHELL  
7 PIN OCTAL 87-47  
OUTLINE 11-1

COATED UNIPOTENTIAL CATHODE

HEATER

6.3 VOLTS 900 MA.

AC OR DC

ANY MOUNTING POSITION

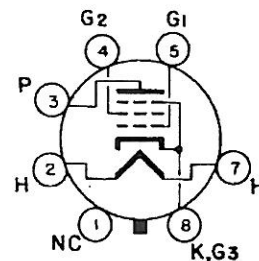

BOTTOM VIEW  
BASING DIAGRAM  
JEDEC 7AC

THE 5881 IS THE ELECTRICAL EQUIVALENT TO TYPES 6L6 AND 6L6G EXCEPT THAT THE PLATE AND SCREEN DISSIPATION RATINGS HAVE BEEN INCREASED APPROXIMATELY 20 PERCENT. IT EMBODIES A COMPLETE MECHANICAL REDESIGN WHICH RESULTS IN GREATER RESISTANCE TO SHOCK AND VIBRATION. THE USE OF TREATED GRIDS AND ANODE GREATLY INCREASES ITS OVERLOAD CAPABILITIES AND THEREBY PROVIDES DESIRABLE IMPROVEMENT IN CONTINUITY OF SERVICE. THE ADDITION OF A LOW-LOSS BARRIER TYPE BASE WILL PROVIDE OBVIOUS ADVANTAGES IN CERTAIN APPLICATIONS.

## RATINGS

INTERPRETED ACCORDING TO DESIGN CENTER SYSTEM

|   |     |        |
|---|-----|--------|
| MAXIMUM HEATER-CATHODE VOLTAGE                | 200 | VOLTS  |
| MAXIMUM PLATE VOLTAGE                         | 400 | VOLTS  |
| MAXIMUM GRID #2 VOLTAGE                       | 400 | VOLTS  |
| MAXIMUM PLATE VOLTAGE (TRIODE CONNECTION)     | 400 | VOLTS  |
| MAXIMUM PLATE DISSIPATION                     | 23  | WATTS  |
| MAXIMUM GRID #2 DISSIPATION                   | 3   | WATTS  |
| MAXIMUM PLATE DISSIPATION (TRIODE CONNECTION) | 26  | WATTS  |
| MAXIMUM GRID RESISTANCE (FIXED BIAS)          | 0.1 | MEGOHM |
| MAXIMUM GRID RESISTANCE (SELF BIAS)           | 0.5 | MEGOHM |

## TYPICAL OPERATING CONDITIONS AND CHARACTERISTICS

CLASS A<sub>1</sub> AMPLIFIER - SINGLE TUBE

|                                |        |        |        |         |
|--------------------------------|--------|--------|--------|---------|
| PLATE VOLTAGE                  | 250    | 300    | 350    | VOLTS   |
| GRID #2 VOLTAGE                | 250    | 200    | 250    | VOLTS   |
| GRID #1 VOLTAGE                | -14    | -12.5  | -18    | VOLTS   |
| PEAK AF SIGNAL VOLTAGE         | 14     | 12.5   | 18     | VOLTS   |
| TRANSCONDUCTANCE               | 6 100  | 5 300  | 5 200  | μMHOS   |
| PLATE RESISTANCE               | 30 000 | 35 000 | 48 000 | OHMS    |
| ZERO-SIGNAL PLATE CURRENT      | 75     | 48     | 53     | MA.     |
| ZERO-SIGNAL GRID #2 CURRENT    | 4.3    | 2.5    | 2.5    | MA.     |
| MAXIMUM SIGNAL PLATE CURRENT   | 80     | 55     | 65     | MA.     |
| MAXIMUM SIGNAL GRID #2 CURRENT | 7.6    | 4.7    | 8.5    | MA.     |
| LOAD RESISTANCE                | 2 500  | 4 500  | 4 200  | OHMS    |
| POWER OUTPUT                   | 6.7    | 6.5    | 11.3   | WATTS   |
| TOTAL HARMONIC DISTORTION      | 10     | 11     | 13     | PERCENT |

CONTINUED ON FOLLOWING PAGE

## TUNG-SOL

CONTINUED FROM PRECEDING PAGE

CLASS A<sub>1</sub> AMPLIFIER - SINGLE TUBE - TRIODE CONNECTION

GRID #2 CONNECTED TO PLATE

|                              |       |       |         |
|------------------------------|-------|-------|---------|
| PLATE VOLTAGE                | 250   | 300   | VOLTS   |
| GRID VOLTAGE                 | -18   | -20   | VOLTS   |
| PEAK AF SIGNAL VOLTAGE       | 18    | 20    | VOLTS   |
| ZERO-SIGNAL PLATE CURRENT    | 52    | 78    | MA.     |
| MAXIMUM SIGNAL PLATE CURRENT | 58    | 85    | MA.     |
| AMPLIFICATION FACTOR         | 8     | ---   |         |
| TRANSCONDUCTANCE             | 5 250 | ---   | μMHOS   |
| LOAD RESISTANCE              | 4 000 | 4 000 | OHMS    |
| TOTAL HARMONIC DISTORTION    | 6     | 5.5   | PERCENT |
| POWER OUTPUT                 | 1.4   | 1.8   | WATTS   |

CLASS A<sub>1</sub> PUSH-PULL AMPLIFIER

VALUES ARE FOR TWO TUBES

|                                |        |        |         |
|--------------------------------|--------|--------|---------|
| PLATE VOLTAGE                  | 250    | 270    | VOLTS   |
| GRID #2 VOLTAGE                | 250    | 270    | VOLTS   |
| GRID #1 VOLTAGE                | -16    | -17.5  | VOLTS   |
| PEAK AF GRID TO GRID VOLTAGE   | 32     | 35     | VOLTS   |
| TRANSCONDUCTANCE (EACH TUBE)   | 5 500  | 5 700  | μMHOS   |
| PLATE RESISTANCE (EACH TUBE)   | 24 500 | 23 500 | OHMS    |
| ZERO-SIGNAL PLATE CURRENT      | 120    | 134    | MA.     |
| ZERO-SIGNAL GRID #2 CURRENT    | 10     | 11     | MA.     |
| MAXIMUM SIGNAL PLATE CURRENT   | 140    | 155    | MA.     |
| MAXIMUM SIGNAL GRID #2 CURRENT | 16     | 17     | MA.     |
| LOAD RESISTANCE                | 5 000  | 5 000  | OHMS    |
| POWER OUTPUT                   | 14.5   | 17.5   | WATTS   |
| TOTAL HARMONIC DISTORTION      | 2      | 2      | PERCENT |

CLASS AB<sub>1</sub> PUSH-PULL AMPLIFIER

VALUES ARE FOR TWO TUBES

|                                |       |       |         |
|--------------------------------|-------|-------|---------|
| PLATE VOLTAGE                  | 360   | 360   | VOLTS   |
| GRID #2 VOLTAGE                | 270   | 270   | VOLTS   |
| GRID #1 VOLTAGE                | -22.5 | -22.5 | VOLTS   |
| PEAK AF GRID TO GRID VOLTAGE   | 45    | 45    | VOLTS   |
| ZERO-SIGNAL PLATE CURRENT      | 88    | 88    | MA.     |
| ZERO-SIGNAL GRID #2 CURRENT    | 5     | 5     | MA.     |
| MAXIMUM SIGNAL PLATE CURRENT   | 132   | 140   | MA.     |
| MAXIMUM SIGNAL GRID #2 CURRENT | 15    | 11    | MA.     |
| LOAD RESISTANCE                | 6 600 | 3 800 | OHMS    |
| POWER OUTPUT                   | 26.5  | 18    | WATTS   |
| TOTAL HARMONIC DISTORTION      | 2     | 2     | PERCENT |

CONTINUED ON FOLLOWING PAGE

## TUN8-50L

CONTINUED FROM PRECEDING PAGE

CLASS AB<sub>1</sub> PUSH-PULL AMPLIFIER - TRIODE CONNECTIONGRID #2 CONNECTED TO PLATE  
VALUES ARE FOR TWO TUBES

|                              |       |         |
|------------------------------|-------|---------|
| HEATER VOLTAGE               | 6.3   | VOLTS   |
| HEATER CURRENT               | 0.9   | AMP.    |
| PLATE VOLTAGE                | 400   | VOLTS   |
| GRID VOLTAGE                 | -45   | VOLTS   |
| PEAK AF GRID TO GRID VOLTAGE | 90    | VOLTS   |
| ZERO-SIGNAL PLATE CURRENT    | 65    | MA.     |
| MAXIMUM SIGNAL PLATE CURRENT | 130   | MA.     |
| LOAD RESISTANCE              | 4 000 | OHMS    |
| TOTAL HARMONIC DISTORTION    | 4.4   | PERCENT |
| POWER OUTPUT                 | 13.3  | WATTS   |

CLASS AB<sub>2</sub> PUSH-PULL AMPLIFIER

VALUES ARE FOR TWO TUBES

|                                |       |       |         |
|--------------------------------|-------|-------|---------|
| HEATER VOLTAGE                 | 6.3   | 6.3   | VOLTS   |
| HEATER CURRENT                 | 0.9   | 0.9   | AMP.    |
| PLATE VOLTAGE                  | 360   | 360   | VOLTS   |
| GRID #2 VOLTAGE                | 225   | 270   | VOLTS   |
| GRID #1 VOLTAGE                | -18   | -22.5 | VOLTS   |
| PEAK AF GRID TO GRID VOLTAGE   | 52    | 72    | VOLTS   |
| ZERO-SIGNAL PLATE CURRENT      | 78    | 88    | MA.     |
| ZERO-SIGNAL GRID #2 CURRENT    | 3.5   | 5     | MA.     |
| MAXIMUM SIGNAL PLATE CURRENT   | 142   | 205   | MA.     |
| MAXIMUM SIGNAL GRID #2 CURRENT | 11    | 16    | MA.     |
| LOAD RESISTANCE                | 6 000 | 3 800 | OHMS    |
| POWER OUTPUT                   | 31    | 47    | WATTS   |
| TOTAL HARMONIC DISTORTION      | 2     | 2     | PERCENT |

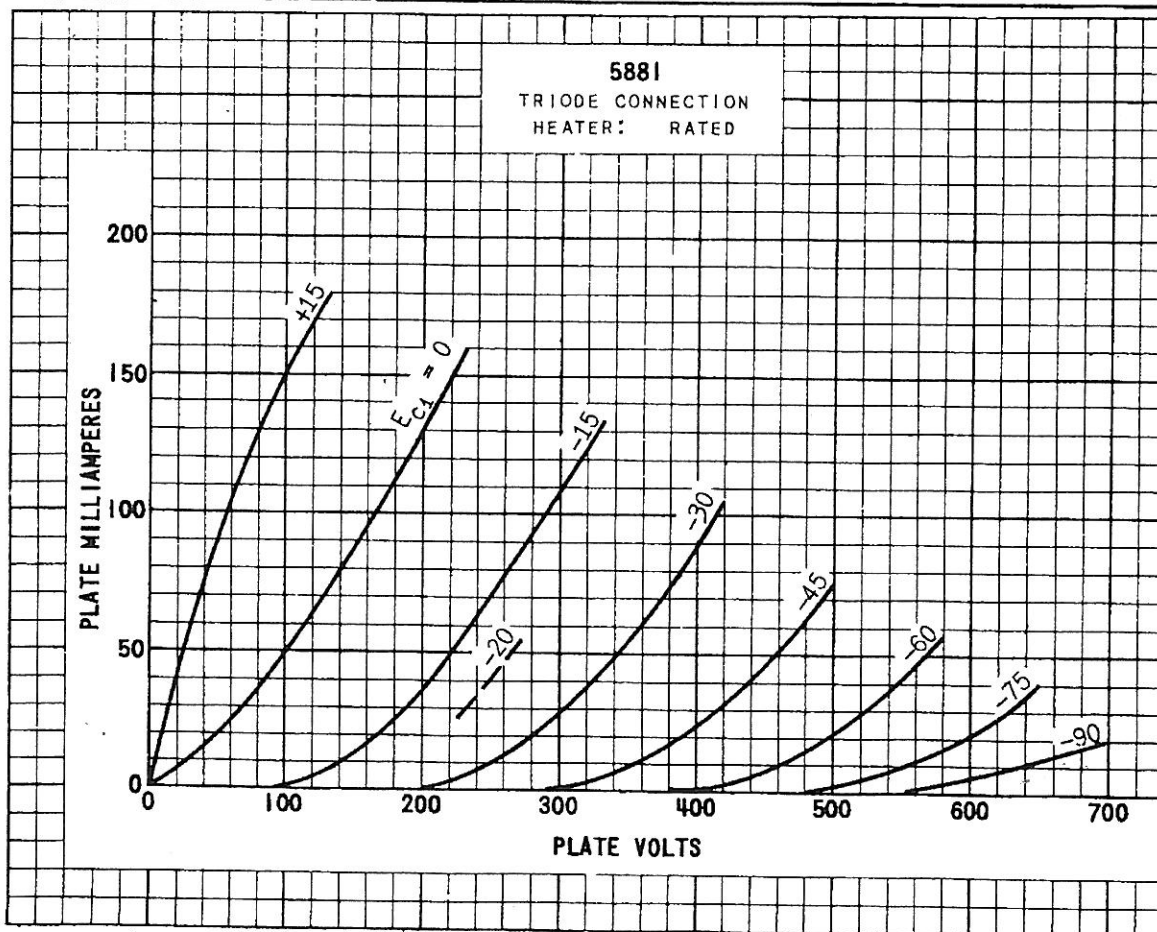

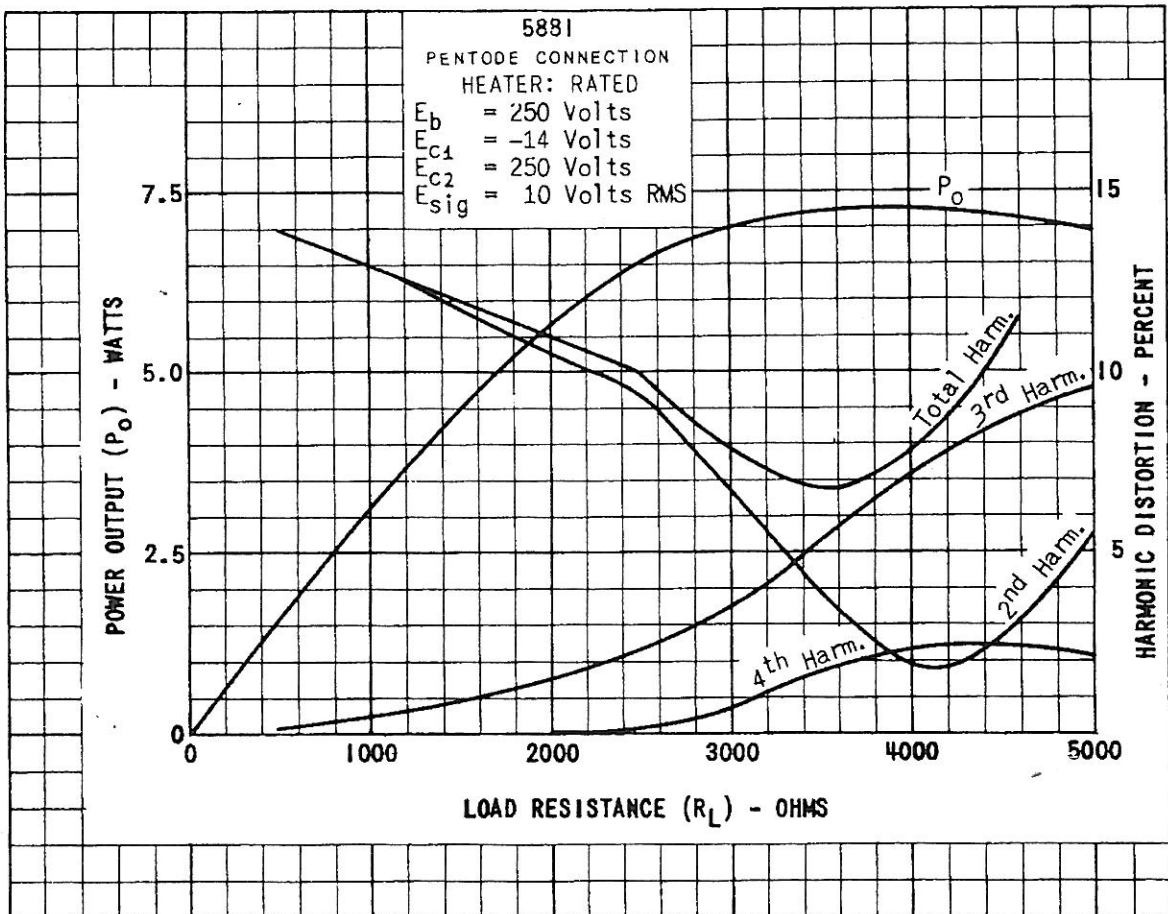
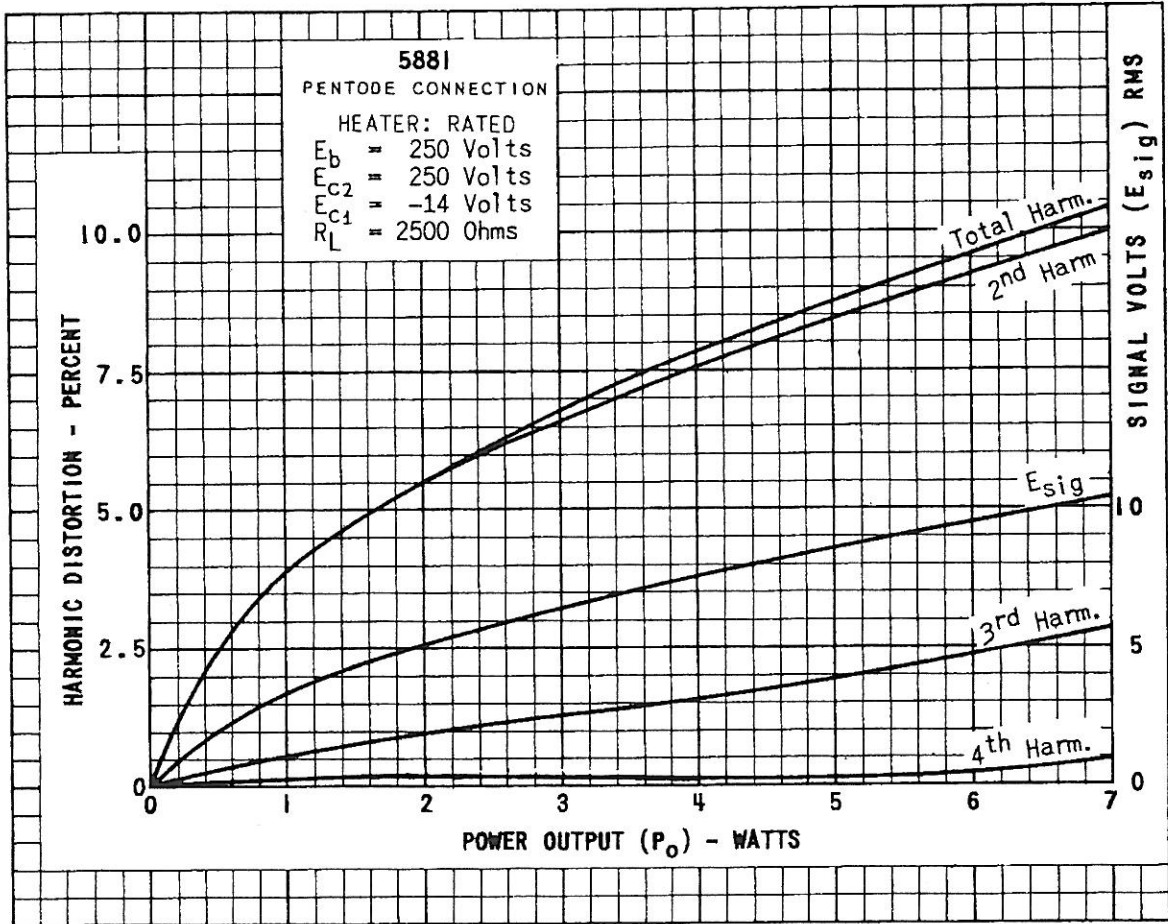

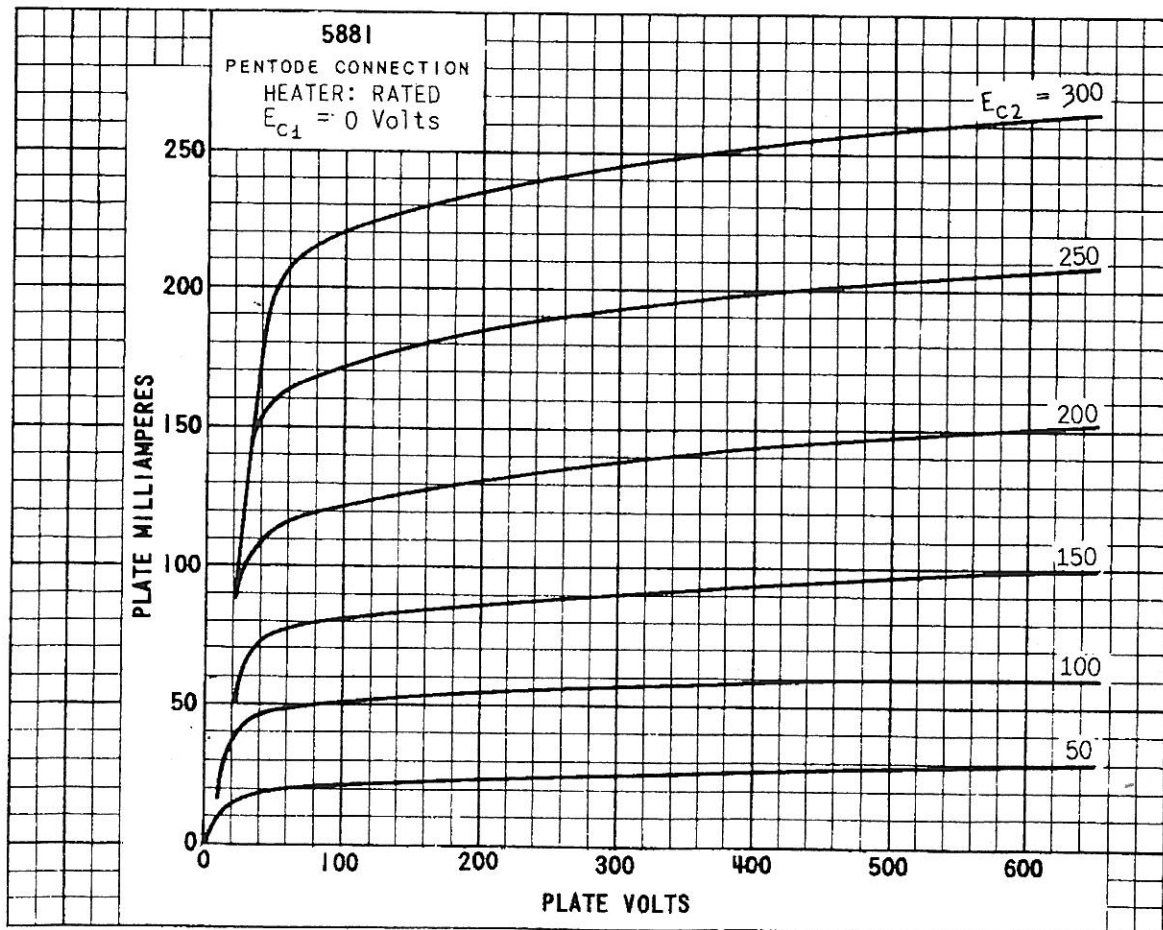
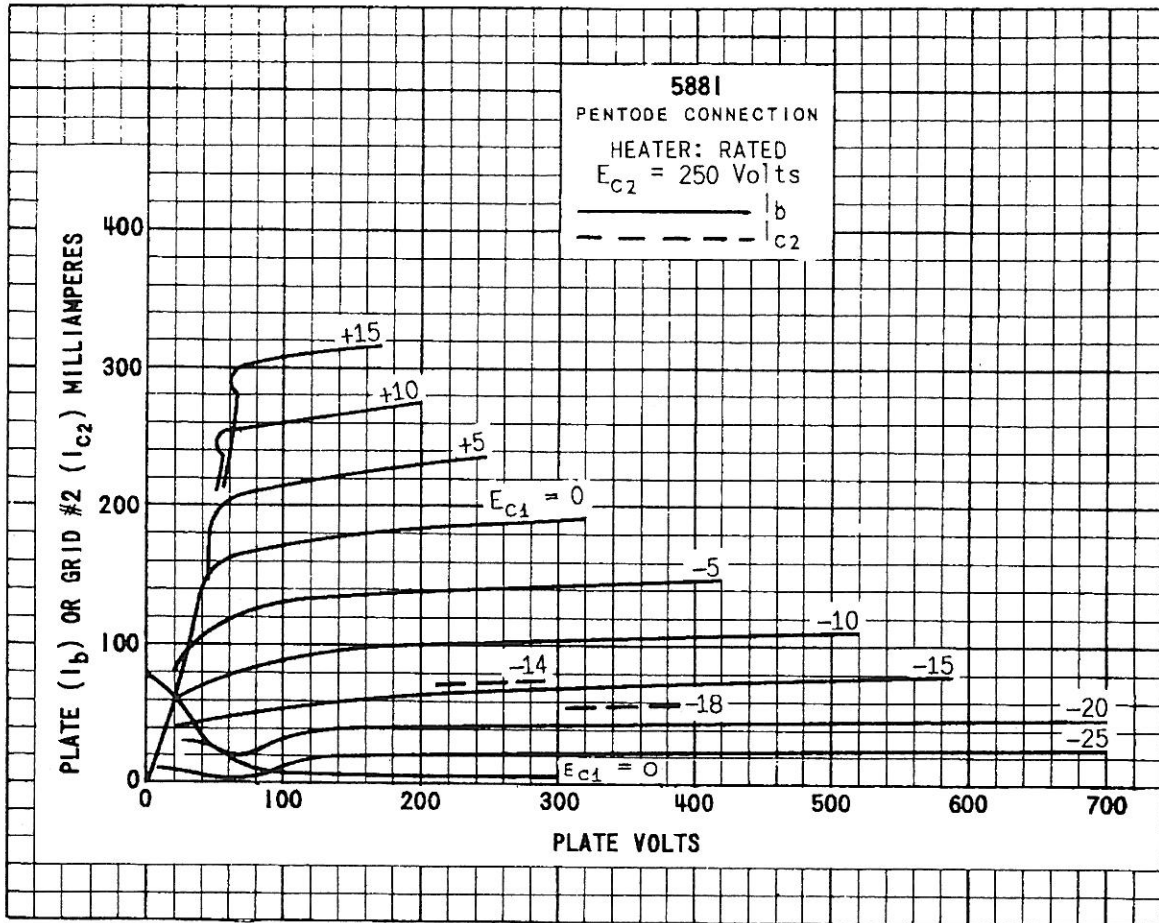

TUNB-SOL

ULTRA-LINEAR OUTPUT STAGE

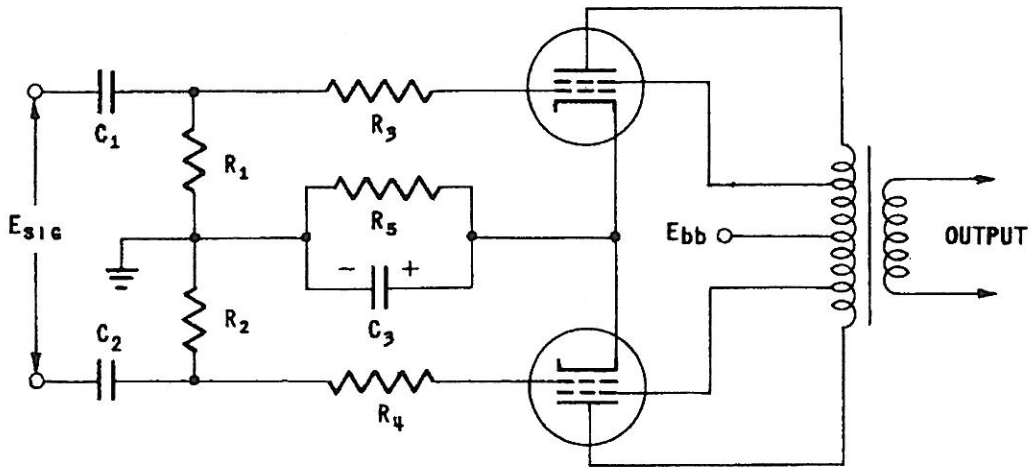

- $R_1, R_2 = 100 \text{ K. } 1/2 \text{ W}$
- $R_3, R_4 = 1 \text{ K. } 1/2 \text{ W}$
- $R_5 = 400 \text{ OHMS } 10 \text{ W}$
- $E_b = 450 \text{ V.}$
- $E_{SIG} = 80 \text{ V. PEAK TO PEAK}$
- $C_1, C_2 = 0.2 \mu\text{f } 600 \text{ V}$
- $C_3 = 100 \mu\text{f } 50 \text{ V}$
- $\text{DIST.} = 2.5\%$
- $P_o = 20 \text{ W}$
- $R_1 = 6 \text{ K}$

IN THE ULTRA-LINEAR CIRCUIT THE SCREEN VOLTAGES ARE DERIVED FROM TAPS ON THE PLATE WINDINGS OF THE OUTPUT TRANSFORMER, THE TAPS ARE LOCATED SO AS TO APPLY 43% OF THE PLATE SIGNAL VOLTAGE TO THE SCREEN GRID.

THE PLATE FAMILY FOR THIS CONNECTION IS SHOWN BELOW. THESE CURVES WERE OBTAINED BY STATICALLY VARYING THE PLATE VOLTAGE IN INCREMENTS ABOUT THE QUIESCENT POINT (400 VOLTS PLATE AND SCREEN SUPPLY) AND SIMULTANEOUSLY CHANGING THE SCREEN VOLTAGE BY 43% OF THE INCREMENT. IN THE GRAPH BOTH PLATE AND SCREEN VOLTAGES HAVE BEEN PLOTTED ALONG THE ABSCISSA.

