

P.C. Board & Chassis Mount (140-141 Series)

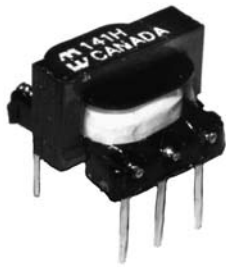

LOW PROFILE - P.C. BOARD MOUNT AUDIO TRANSFORMERS

- Pin type (0.25" length & 0.035" diameter), P.C. board mount
- Low profile, open type construction
- Frequency response 200 Hz. - 15 KHz. (+/- 2 db, ref. @ 1 KHz.)
- Net weight 0.6 oz.

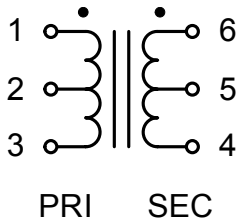

Part No.	Nominal Impedance		Max. Pri. D.C. ma	D.C. Resistance		Output Milliwatts
	Primary	Secondary		Primary	Secondary	
141B	200K	1000	0	3775	85	4
141D	3000 C.T.	1000 C.T.	1	120	51	150
141F	25K	50	2	1645	65	100
141H	600 C.T.	600 C.T.	2	32	45	150
141M	30K	1200 C.T.	2	1100	47	100
141P	1200 C.T.	8	2	50	0.45	150

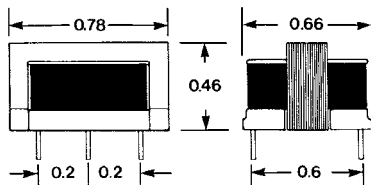

Audio

CHASSIS MOUNT - SHIELDED AUDIO TRANSFORMERS



- Insulated leads 5" long minimum
- Stamped steel case (Diameter of 1.25" and height of 1") for excellent shielding - low hum pick-up.
- Frequency response 70 Hz. - 11 KHz. (+/- 1 db, ref. @ 1 KHz.)
- Case hole mounting centers are 1.6"
- Net weight 2 oz.

Part No.	Application	Nominal Impedance		Overall Turns Ratio
		Primary	Secondary	Pri. to Sec.
140A	Voice Coil to Single Grid	4	60000	1:122
140B	Dyn. MIC. to Single Grid	30	60000	1:45
140C	MIC. to Single Grid	50	60000	1:34.5
140H	Bridging Line to P.P. Grids	10000	40000 C.T.	1:2
140K	MIC. to Single Grid	150	60000	1:2
140M	CRYS, MIC. to Base	100K	1500	8:1
140N	Dyn. MIC to Base	50	1500	1:5.5
140P	Line to Base	150/600	600/2400	1:2
140Q	Line to Line	600 C.T.	600 C.T.	1:1



CANADA
Guelph, Ontario (519) 822-2960
St. Laurent, Quebec (514) 343-9010
USA
Cheektowaga, NY (716) 630-7030

www.hammondmfg.com



EUROPE
Basingstoke, UK 01256 812812

AUSTRALIA
Queenstown, Australia 61-8-8240-2244

Chassis Mount (143-146 Series)

CHASSIS MOUNT AUDIO TRANSFORMERS

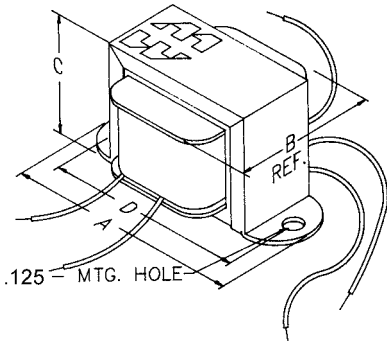

- Economical, open, two hole horizontal bracket mount.
- Insulated, color coded flexible leads, 4" long minimum (143, 144 & 145 Series) or 3" long minimum (146 Series).
- For a similar, P.C. board mount version, refer to our 148 & 149 Series.
- Frequency response 150 Hz. to 15 KHz. (+/- 1 db, reference 1000 Hz.)
- When operating at impedances below nominal, power capability and the frequency spectrum are proportionately lower, conversely, at higher impedances power capability and frequency spectrum will be proportionately higher.
- Net weight: 0.5 oz. (143, 144 & 146 Series) & 1.4 oz. (145 Series).

Series No.	Dimensions (Inches)			
	A	B	C	D
143...	1.35	0.69	0.69	1.06
144...	1.35	0.69	0.69	1.06
145...	1.63	0.88	0.81	1.38
146...	1.63	0.88	0.81	1.38

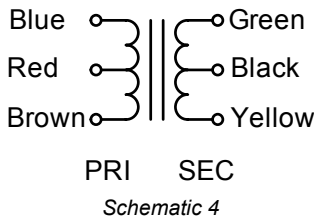
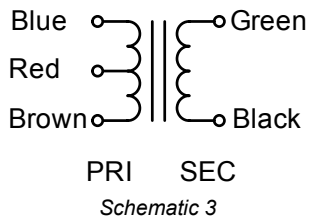
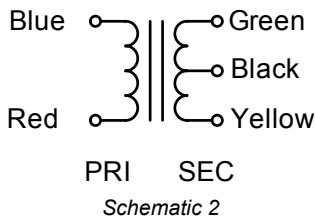
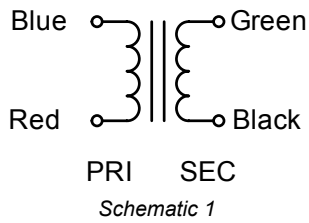

Part No.	Application	Nominal Impedance		Pri. D.C. (*1) ma	D.C. Resistance +/- 15%		Output mW	Sch.
		Primary	Secondary		Primary	Secondary		
143B	Input	3.2	4000	0	0.4	245	15	1
143D	Input	200K	1000	0	4500	30	25	1
143H	Driver	1500	500 C.T.	4	111	24	30	2
143J	Driver	3000	1000 C.T.	2.6	265	53	30	2
143L	Driver	10000	200 C.T.	1.5	720	9	30	2
143N	Driver	10000	2000 C.T.	1.5	720	89	30	2
143R	Driver	25000	600 C.T.	1	1890	25	30	2
144B	Output	200 C.T.	3.2	10	10	0.33	150	3
144D	Output	300 C.T.	3.2	9	15	0.33	150	3
144F	Output	500 C.T.	3.2	6	27	0.33	150	3
144G	Output	500 C.T.	8	6	27	0.9	150	3
144H	Output	500 C.T.	50	6	28	7.3	150	3
144I	Output	600 C.T.	150 C.T.	6	45	8.2	150	4
144P	Output	10000	3.2	5	575	0.5	50	1
144Q	Output	10000	8	5	575	0.9	50	1
144S	Output	20000	8	3.5	1240	0.9	50	1
145A	Driver	100	200 C.T.	45	14	19	100	2
145B	Driver-Output	600	600	18	30	38	200	1
145C	Input	50000	1500 C.T.	1	2400	52	50	2
145D	Input	200K	1000	0.5	3600	33	10	1
145E	Input-Output	600 C.T.	600 C.T.	5	65	83	200	4
145F	Driver	600 C.T.	200 C.T.	20	45	9	135	4
145G	Driver	2000	200 C.T.	12	140	9	135	2
145H	Driver	2000	500 C.T.	12	148	17	135	2
145J	Driver	4000	600 C.T.	8	340	24	135	2
145L	Driver	4000	2600 C.T.	8	340	100	135	2
145N	Driver	10000	2000 C.T.	5	700	89	135	2
145O	Driver	15000	200 C.T.	4	850	10	135	2
145P	Driver	20000	1000 C.T.	3.5	1180	50	135	2
145R	Driver	20000	2000 C.T.	3.5	1180	89	135	2
146B	Output	48 C.T.	3.2	20	2.4	0.3	700	3
146C	Output	48 C.T.	8	20	2.4	0.7	700	3
146D	Output	100 C.T.	3.2	14	4.4	0.3	700	3
146E	Output	100 C.T.	8	14	4.4	0.7	700	3
146F	Output	250 C.T.	3.2	8	11	0.3	700	3
146G	Output	250 C.T.	8	8	11	0.7	700	3
146H	Output	500 C.T.	3.2	6	26	0.3	700	3
146I	Output	500 C.T.	8	6	26	0.7	700	3
146J	Output	1000 C.T.	3.2	4	56	0.3	700	3
146K	Output	1000 C.T.	8	4	56	0.7	700	3
146N	Output	2000 C.T.	8	3	97	0.7	700	3
146S	Output	4000 C.T.	8	2	220	0.7	700	3

NOTES:

*1) For output transformers this figure is maximum unbalance.

EUROPE

Basingstoke, UK 01256 812812

AUSTRALIA

Queenstown, Australia 61-8-8240-2244

www.hammondmfg.com



CANADA

Guelph, Ontario (519) 822-2960
St. Laurent, Quebec (514) 343-9010

USA

Cheektowaga, NY (716) 630-7030



Audio